

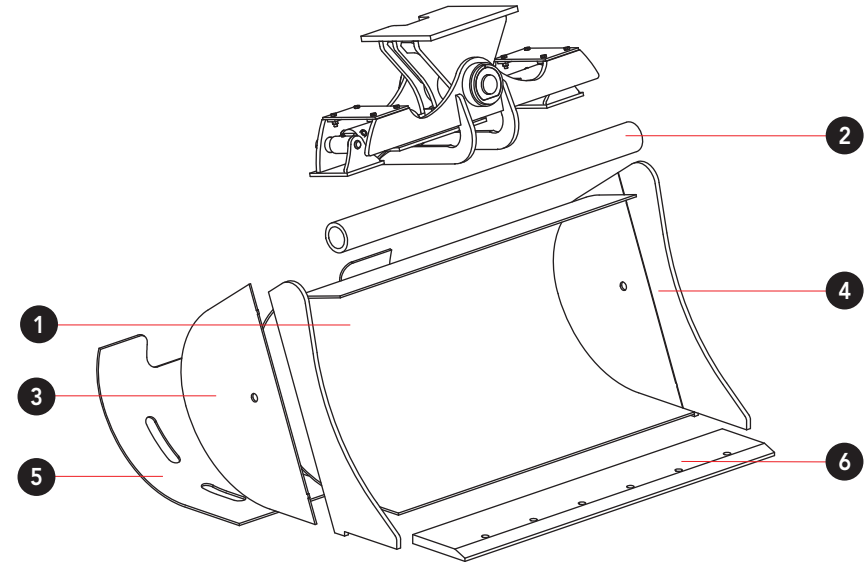

BENNA ORIENTABILE DA SCAVO & CARICO RINFORZATA

REINFORCED SWIVELING DIGGING & LOADING BUCKET

GODET RENFORCÉ INCLINABLE CREUSAGE & CHARGEMENT



Nota / Note

Specifiche idrauliche a pg. 288 - 293

Hydraulic specifications at pg. 288 - 293

Spécifications hydrauliques voir pg. 288 - 293

			1	2	3	4	5	6
Classe	V-55	t 12 - 15	S355 - 6 mm	S355 - Ø 114 mm	S355 - 8 mm	S355 - 20 mm	≥HB400 - 6 mm	≥HB400 - 25 mm
	V-58	t 15 - 19	S355 - 8 mm	S355 - Ø 114 mm	S355 - 8 mm	≥HB400 - 20 mm	≥HB400 - 8 mm	≥HB400 - 35 mm
Class	V-63 / V-64	t 19 - 26	S355 - 10 mm	S355 - Ø 152 mm	S355 - 10 mm	≥HB400 - 25 mm	≥HB400 - 8 mm	≥HB400 - 35 mm
Classe	V-68	t 26 - 31	S355 - 10 mm	S355 - Ø 178 mm	S355 - 10 mm	≥HB400 - 30 mm	≥HB400 - 8 mm	≥HB400 - 35 mm
	V-70	t 31 - 40	S355 - 12 mm	S355 - Ø 178 mm	S355 - 10 mm	≥HB400 - 30 mm	≥HB400 - 10 mm	≥HB400 - 45 mm





BENNA ORIENTABILE DA SCAVO & CARICO RINFORZATA

REINFORCED SWIVELING DIGGING & LOADING BUCKET



GODET RENFORCÉ INCLINABLE CREUSAGE & CHARGEMENT



V-55 t 12-15

Code	L mm	RL mm	P mm	RS mm	ISO 7451 m ³	 n.	 kg	€	Optionals	
									Code	
0748Q2	1400	840	908	1217	0,695	2	635	-	PL14025RS25	-
0748R2	1500	840	908	1217	0,750	2	659	-	PL15025RS25	-
0748T2	1600	840	908	1217	0,805	2	680	-	PL16025RS25	-
0748A2	1800	840	908	1217	0,916	2	729	-	PL18025RS25	-

V-58 t 15-19

Code	L mm	RL mm	P mm	RS mm	ISO 7451 m ³	 n.	 kg	€	Optionals	
									Code	
0755Q2	1400	958	1017	1355	0,940	2	815	-	PL14025RS25	-
0755R2	1500	958	1017	1355	1,017	2	837	-	PL15025RS25	-
0755T2	1600	958	1017	1355	1,093	2	865	-	PL16025RS25	-
0755A2	1800	958	1017	1355	1,246	2	921	-	PL18025RS25	-

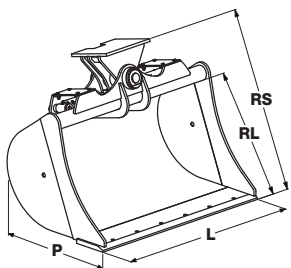





BENNA ORIENTABILE DA SCAVO & CARICO RINFORZATA



REINFORCED SWIVELING DIGGING & LOADING BUCKET

GODET RENFORCÉ INCLINABLE CREUSAGE & CHARGEMENT

V-63 / V-64 t 19-26



									Optionals	
Code	L mm	RL mm	P mm	RS mm	ISO 7451 m ³	 n.	 kg	€	Code	
0758Q2	1400	1045	1148	1485	1,110	2	1078	-	PL14025RS25	-
0758R2	1500	1045	1148	1485	1,202	2	1113	-	PL15025RS25	-
0758T2	1600	1045	1148	1485	1,293	2	1162	-	PL16025RS25	-
0758A2	1800	1045	1148	1485	1,475	2	1223	-	PL18025RS25	-

V-68 t 26-31

									Optionals	
Code	L mm	RL mm	P mm	RS mm	ISO 7451 m ³	 n.	 kg	€	Code	
0763Q2	1400	1165	1351	1575	1,411	2	1446	-	PL14033RS251	-
0763R2	1500	1165	1351	1575	1,530	2	1569	-	PL15033RS25	-
0763T2	1600	1165	1351	1575	1,649	2	1612	-	PL16033RS25	-
0763A2	1800	1165	1351	1575	1,890	2	1695	-	PL18033RS25	-

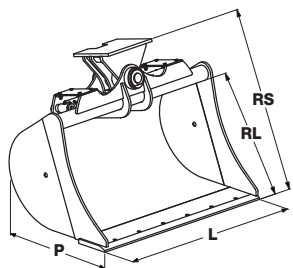
V-70 t 31-40



									Optionals	
Code	L mm	RL mm	P mm	RS mm	ISO 7451 m ³	 n.	 kg	€	Code	
0763HDA2	1800	1173	1351	1650	1,890	2	1934	-	PL18033RS25	-
0763HDB2	2000	1173	1351	1650	2,130	2	2059	-	PL20033RS25	-
0763HDJ2	2200	1173	1351	1650	2,360	2	2190	-	PL22033RS25	-
0763HDW2	2400	1173	1351	1650	2,600	2	2408	-	PL24033RS251	-



BENNA ORIENTABILE PER MINIESCAVATORI - PROFILO ROTONDO
SWIVELING DITCH CLEANING BUCKET FOR MINIEXCAVATORS - ROUND PROFILE
GODET INCLINABLE POUR MINIPELLES - PROFIL ARRONDI

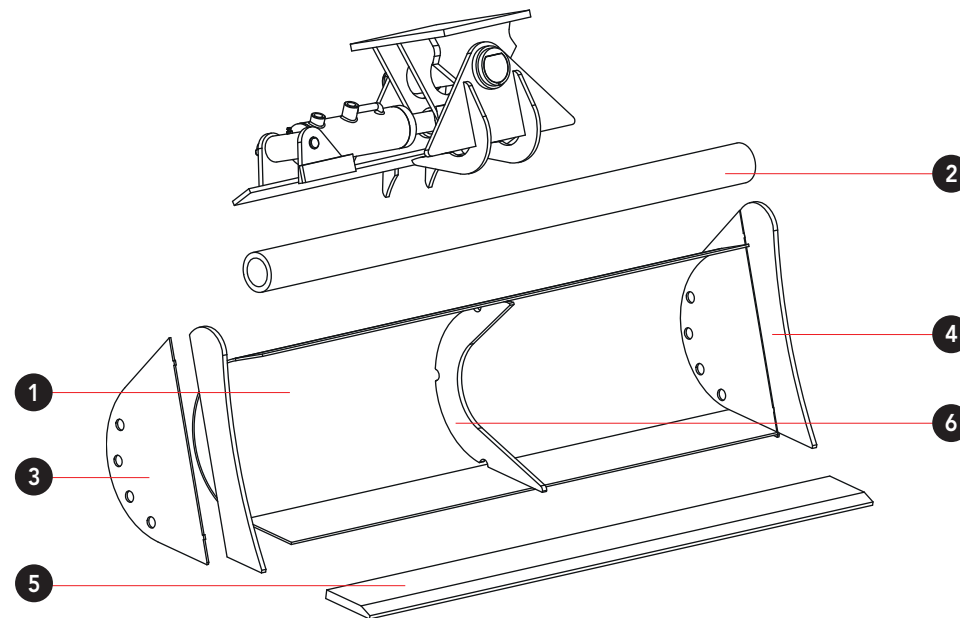



			1	2	3	4	5	6
Classe Class Classe	V-20	t 1,4 - 1,8	S355 - 4 mm	S355 - Ø 60 mm	S355 - 4 mm	S355 - 10 mm	≥HB250 - 15 mm	S355 - 8 mm
	V-25	t 1,8 - 2,5	S355 - 4 mm	S355 - Ø 70 mm	S355 - 4 mm	S355 - 10 mm	≥HB250 - 15 mm	S355 - 10 mm
	V-30	t 2,5 - 3,3	S355 - 4 mm	S355 - Ø 70 mm	S355 - 5 mm	S355 - 12 mm	≥HB250 - 15 mm	S355 - 12 mm
	V-35 / V-38	t 3,3 - 5,8	S355 - 6 mm	S355 - Ø 89 mm	S355 - 6 mm	S355 - 15 mm	≥HB250 - 20 mm	S355 - 12 mm
	V-45 / V-46	t 5,8 - 11	S355 - 6 mm	S355 - Ø 102 mm	S355 - 6 mm	S355 - 15 mm	≥HB400 - 20 mm	S355 - 15 mm



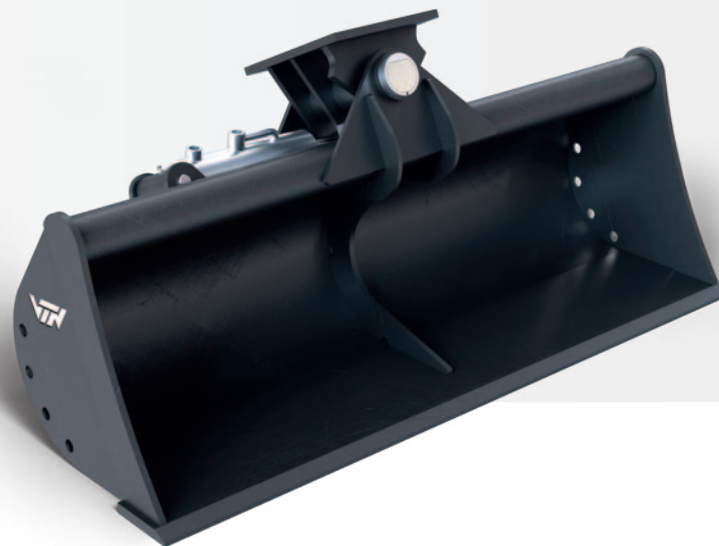

BENNA ORIENTABILE PER MINIESCAVATORI - PROFILO ROTONDO
SWIVELING DITCH CLEANING BUCKET FOR MINIEXCAVATORS - ROUND PROFILE
GODET INCLINABLE POUR MINIPELLES - PROFIL ARRONDI



V-20 t 1,4-1,8

Code	L mm	RL mm	P mm	RS mm	ISO 7451 m ³	 n.	 kg	€	Optionals 
07031R53	850	342	345	532	0,071	1	84	-	-
07031R53	1000	342	345	532	0,086	1	90	-	-

V-25 t 1,8-2,5

Code	L mm	RL mm	P mm	RS mm	ISO 7451 m ³	 n.	 kg	€	Optionals 
07041R53	1000	382	384	598	0,110	1	106	-	-
0704NR53	1200	382	384	598	0,134	1	116	-	-

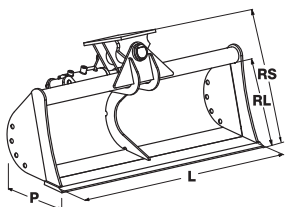





BENNA ORIENTABILE PER MINIESCAVATORI - PROFILO ROTONDO



SWIVELING DITCH CLEANING BUCKET FOR MINIEXCAVATORS - ROUND PROFILE

GODET INCLINABLE POUR MINIPELLES - PROFIL ARRONDI



V-30 t 2,5-3,3

Code	L mm	RL mm	P mm	RS mm	ISO 7451 m ³	 n.	 kg	€	Optionals
									
07051R53	1000	429	446	640	0,135	1	116	-	-
0705NR53	1200	429	446	640	0,165	1	127	-	-
0705QR53	1400	429	446	640	0,195	1	138	-	-

V-35 / V-38 t 3,3-5,8

Code	L mm	RL mm	P mm	RS mm	ISO 7451 m ³	 n.	 kg	€	Optionals
									
0707MR53	1200	462	483	753	0,200	1	219	-	-
0707QR53	1400	462	483	753	0,236	1	236	-	-
0707RR53	1500	462	483	753	0,254	1	244	-	-

V-45 / V-46 t 5,8-11

Code	L mm	RL mm	P mm	RS mm	ISO 7451 m ³	 n.	 kg	€	Optionals
									
0710NR53	1200	531	568	811	0,256	1	253	-	-
0710QR53	1400	531	568	811	0,303	1	271	-	-
0710RR53	1500	531	568	811	0,326	1	281	-	-
0710TR53	1600	531	568	811	0,350	1	290	-	-
0710AR53	1800	531	568	811	0,396	1	310	-	-

